



Document Title	M101GWN9 R2 Product Specification			Page No.	1/23
Document No.		Issue date	2014/5/16	Revision	00

## Product Specification

**To:**

**Product Name: M101GWN9 R2**

**Document Issue Date: 2014/05/16**

<b>Customer</b>	<b>InfoVision Optoelectronics</b>
<p><b><u>SIGNATURE</u></b></p>  <p>_____</p>  <p>_____</p>  <p>_____</p> <p>Please return 1 copy for your confirmation with your signature and comments.</p>	<p><b><u>SIGNATURE</u></b></p>  <p><b>REVIEWED BY QA</b></p>  <p>_____</p>  <p><b>PREPARED BY FAE</b></p>  <p>_____</p>

- Note: 1. Please contact InfoVision Company before designing your product based on this product.  
 2. The information contained herein is presented merely to indicate the characteristics and performance of our products. No responsibility is assumed by IVO for any intellectual property claims or other problems that may result from application based on the module described herein.

FQ-7-30-0-009-03C



昆山龙腾光电有限公司  
InfoVision Optoelectronics ( Kunshan ) Co.,LTD.

Document Title	M101GWN9 R2 Product Specification			Page No.	2/23
Document No.		Issue date	2014/5/16	Revision	00

Revision	Date	Page	Old Description	New Description	Remark
00	2014/05/16	all	--	First issue.	



Document Title	M101GWN9 R2 Product Specification			Page No.	3/23
Document No.		Issue date	2014/5/16	Revision	00

## Contents

<b>1.0 General Descriptions Introduction</b> .....	4
<b>2.0 Absolute Maximum Ratings</b> .....	5
<b>3.0 Pixel Format Image</b> .....	6
<b>4.0 Optical Characteristics</b> .....	7
<b>5.0 Backlight Characteristics (Reference)</b> .....	10
<b>6.0 Electrical Characteristics</b> .....	11
<b>7.0 Interface Timings</b> .....	14
<b>8.0 Power Consumption</b> .....	15
<b>9.0 Power ON/OFF Sequence</b> .....	15
<b>10.0 Reliability Test Criteria</b> .....	17
<b>11.0 Mechanical Characteristics</b> .....	18
<b>12.0 Package Specification</b> .....	19
<b>13.0 Lot Mark</b> .....	20
<b>14.0 General Precaution</b> .....	21



Document Title	M101GWN9 R2 Product Specification			Page No.	4/23
Document No.		Issue date	2014/5/16	Revision	00

## 1.0 General Descriptions Introduction

### 1.1 Introduction

The M101GWN9 R2 is a color active matrix thin film transistor (TFT) liquid crystal display (LCD) that uses amorphous silicon TFT as a switching device. It is composed of a TFT LCD panel, column driver and row driver circuit. This TFT LCD has a 10.1-inch diagonally measured active display area with WSVGA resolution (1024 horizontal by 600 vertical pixels array).

### 1.2 Features

- 10.1" TFT LCD Panel
- Supported WSVGA resolution
- Compatible with RoHS standard

### 1.3 Product Summary

Items	Specifications	Unit
Screen Diagonal	10.1	Inch
Active Area	222.72(H) x 125.28(V)	mm
Pixels H x V	1024(RGB) x600	-
Pixel Pitch	0.2175(H) x 0.2088(V)	mm
Pixel Arrangement	RGB Vertical Stripe	-
Display Mode	Normally White	-
Contrast Ratio	(500) (Typ.)	-
Response Time	16 (Typ.)	ms
Input Voltage	+3.3 (Typ.)	V
Weight	310 (Typ.)	g
Outline Dimension (H x V x D)	235(Typ.) x 143(Typ.) x 7.54(Typ.)	mm
Electrical Interface (Logic)	LVDS	-
Support Color	16.7M	-
Surface Treatment	Anti-glare, Hard-Coating (3H)	-

Document Title	M101GWN9 R2 Product Specification			Page No.	5/23
Document No.		Issue date	2014/5/16	Revision	00

### 1.4 Functional Block Diagram

Figure 1 shows the functional block diagram of the LCD module.

**Figure 1 Block Diagram**

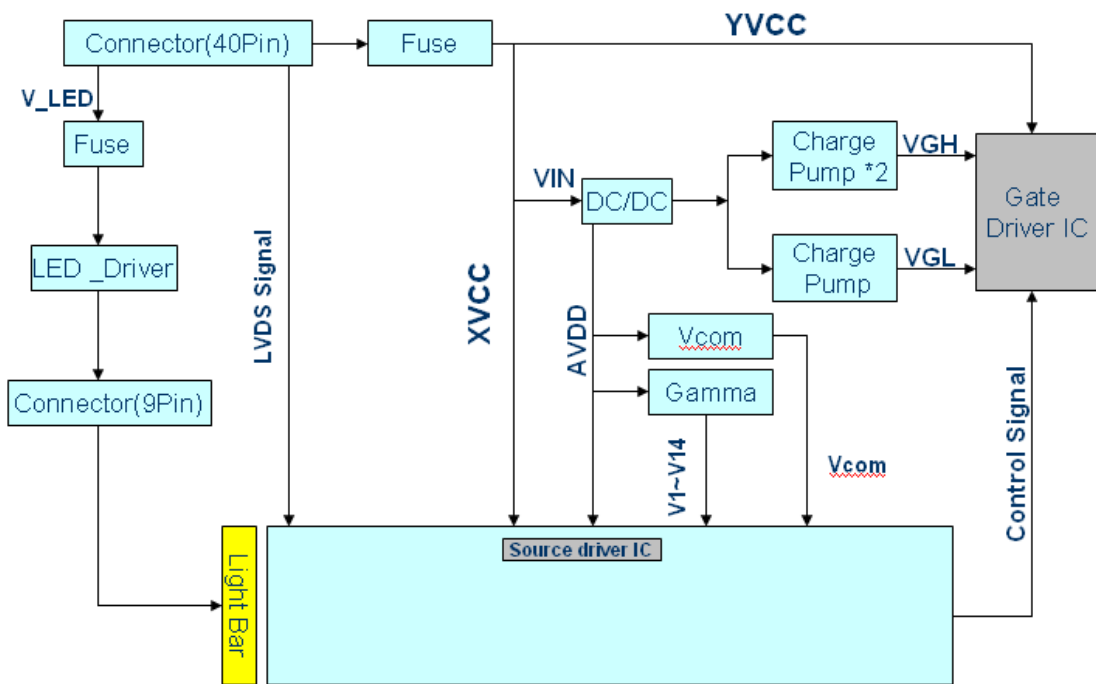



Document Title	M101GWN9 R2 Product Specification			Page No.	6/23
Document No.		Issue date	2014/5/16	Revision	00

## 2.0 Absolute Maximum Ratings

**Table 1 Electrical Absolute Rating**

ITEM	SYMBOL	MIN.	MAX.	UNIT	REMARK
Supply Voltage	$V_{IN}$	-0.3	3.96	V	Logic power supply voltage
		-0.3	12	V	LED Driver Vin
Power Supply Fuse Current Setting	$I_{FUSE}$	-	1.5	A	Vin from 10% ~ 90% , rise time 500us
Input Signal	$V_S$	-	3.6	V	LVDS signals
EN/PWM Voltage	$V_{PWM}$	-0.3	12	V	EN/PWM Voltage

**Table 2 Absolute Ratings of Environment**

Item	Symbol	Min.	Max.	Unit	Conditions
Operating Temperature	TOP	-20	70	°C	(1) (2) (3) (4)
Operating Humidity	HOP	10	85	%RH	-
Storage Temperature	TST	-30	80	°C	-
Storage Humidity	HST	10	90	%RH	-

Note (1): Humidity: 85%RH Max. ( $T \leq 40^\circ\text{C}$ ) Note static electricity. Maximum wet bulb temperature at  $39^\circ\text{C}$  or less. ( $T > 40^\circ\text{C}$ ) No condensation.

Note (2): There is a possibility of causing deterioration in the irregularity and others of the screen and the display fineness though the liquid crystal module doesn't arrive at destruction when using it at  $60 \sim 70^\circ\text{C}$  or  $-20 \sim 0^\circ\text{C}$ .

Note (3): There is a possibility of causing the fineness deterioration by the prolonged use in the (high temperature) humidity environment (60% or more).

Note (4): In the operating temperature item, the low temperature side is the ambient temperature regulations. The high temperature side is the panel surface temperature regulations.

Document Title	M101GWN9 R2 Product Specification	Page No.	7/23
Document No.	Issue date	2014/5/16	Revision 00

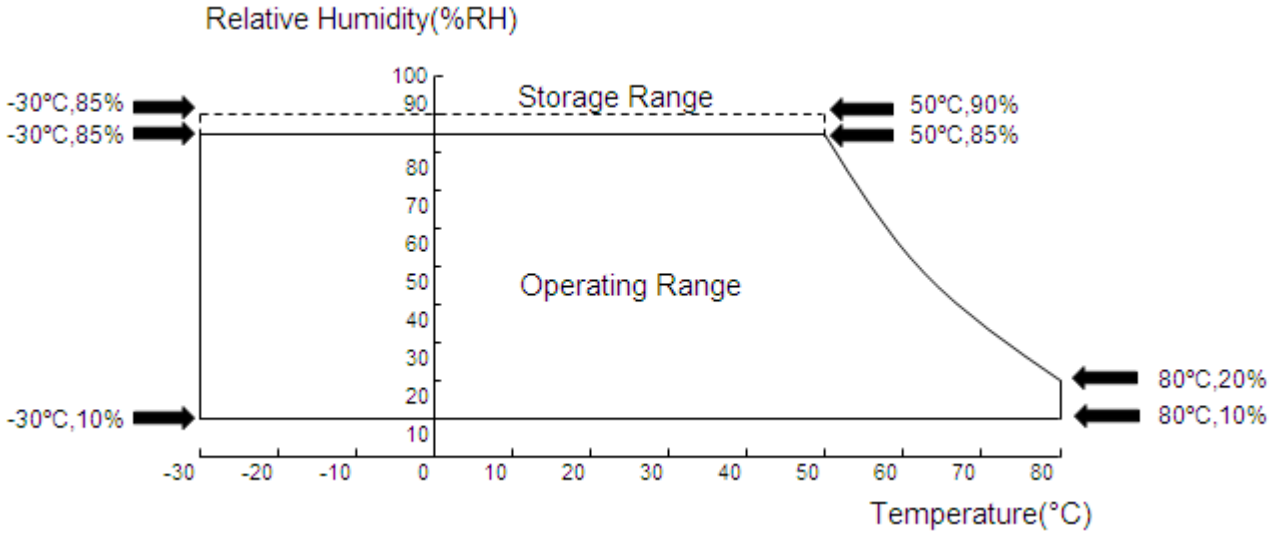

### 3.0 Pixel Format Image

Figure 2 shows the relationship of the input signals and LCD pixel format image.

**Figure 2 Pixel Format**

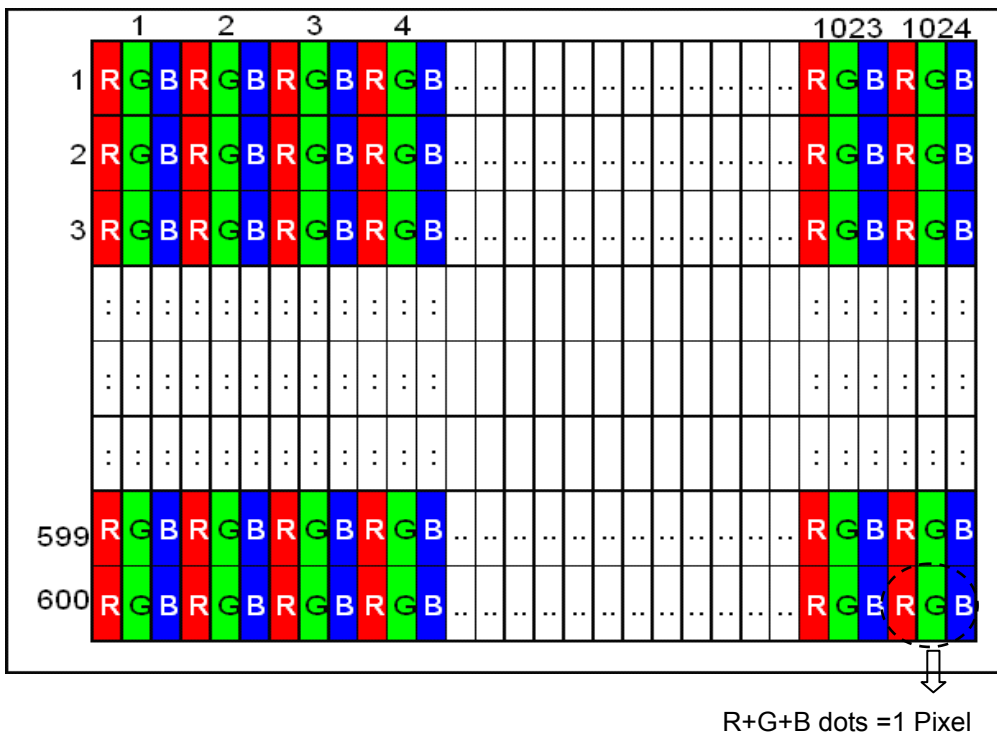



Document Title	M101GWN9 R2 Product Specification			Page No.	8/23
Document No.		Issue date	2014/5/16	Revision	00

#### 4.0 Optical Characteristics

The optical characteristics are measured under stable conditions as following notes

**Table 3 Optical Characteristics**

Item	Conditions		Min.	Typ.	Max.	Unit	Note
Viewing Angle (CR>10)	Horizontal	$\theta_L$	(70)	(80)	-	degree	(1),(2), (3)
		$\theta_R$	(70)	(80)	-		
	Vertical	$\theta_T$	(70)	(80)	-		
		$\theta_B$	(70)	(80)	-		
Contrast Ratio	Center		(400)	(500)	-	-	(1),(2), (4)
Response Time	Rising		-	(6)	(12)	ms	(1),(2),(5)
	Falling		-	(10)	(20)	ms	
	Rising + Falling		-	16	(32)	ms	
Chromaticity (CIE1931)	NTSC		(42)	(45)	-	%	(1),(2)
	Red	x	Typ. -0.03	(0.582)	Typ. -0.03	-	
	Red	y		(0.344)		-	
	Green	x		(0.333)		-	
	Green	y		(0.595)		-	
	Blue	x		(0.162)		-	
	Blue	y		(0.143)		-	
	White	x		(0.255)		(0.305)	
White	y	(0.275)		(0.325)		(0.375)	-
White Luminance	Center		(280)	(350)	-	cd/m <sup>2</sup>	(1),(2),(6)
Luminance Uniformity	9Points		(75)	(80)	-	%	(1),(2),(6)

**Note (1) Measurement Setup:**

The LCD module should be stabilized at given temperature(25°C) for 15 minutes to Avoid abrupt temperature change during measuring. In order to stabilize the luminance, the measurement should be executed after lighting backlight for 15 minutes in a windless room.



Document Title	M101GWN9 R2 Product Specification			Page No.	9/23
Document No.		Issue date	2014/5/16	Revision	00

**Figure 3 Measurement Setup**

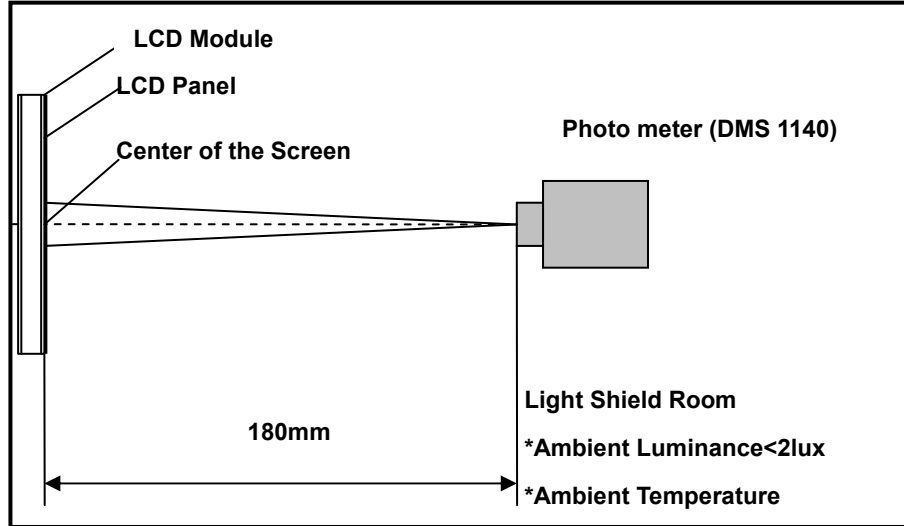

Note (2) The LED input parameter setting as:

VLED: 5V;

PWM\_LED: Duty 100 %

Note (3) Definition of Viewing Angle

**Figure 4 Definition of Viewing Angle**

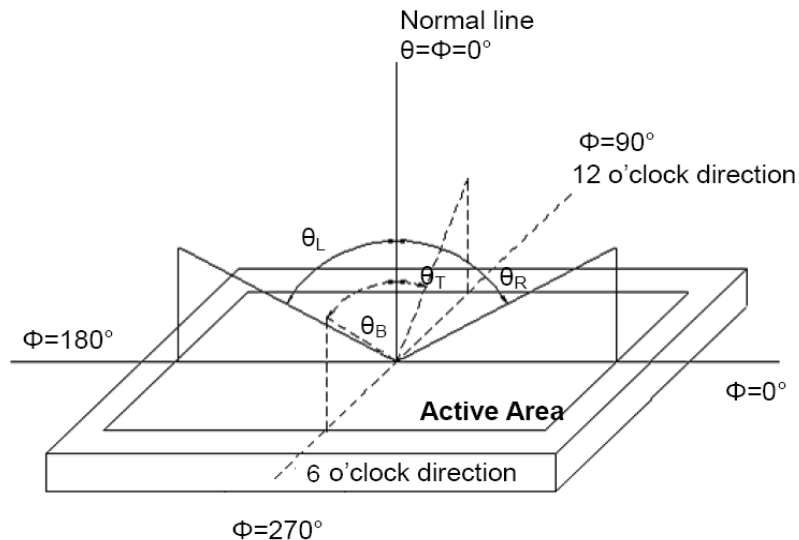

Note (4) Definition of Contrast Ratio (CR)

The contrast ratio can be calculated by the following expression

$$\text{Contrast Ratio (CR)} = L_{255} / L_0$$

L255: Luminance of gray level 255, L0: Luminance of gray level 0

Document Title	M101GWN9 R2 Product Specification			Page No.	10/23
Document No.		Issue date	2014/5/16	Revision	00

Note (5) Definition of Response Time ( $T_R$ ,  $T_F$ )

**Figure 5 Definition of Response Time**

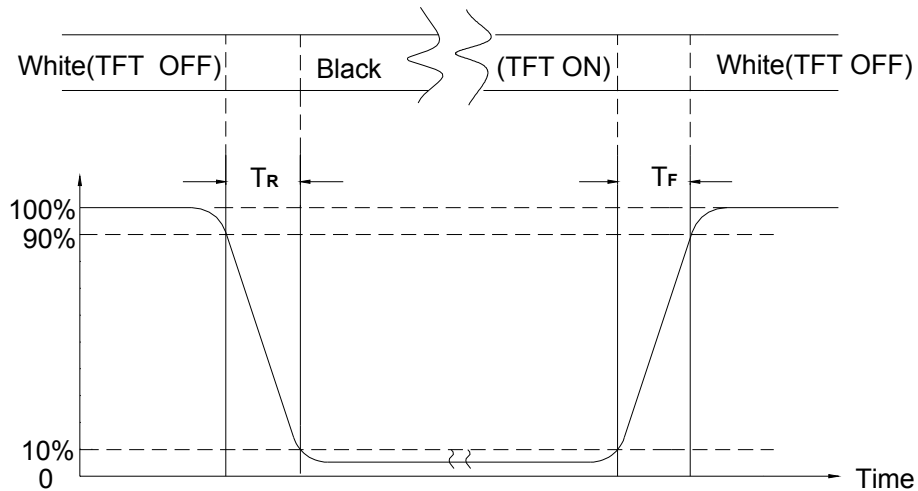

Note (6) Definition of Brightness Luminance

$$\text{Luminance Uniformity} = \frac{(\text{Min Luminance of 9 points})}{(\text{Max Luminance of 9 points})} \times 100\%$$

**Figure 6 Measurement Locations**

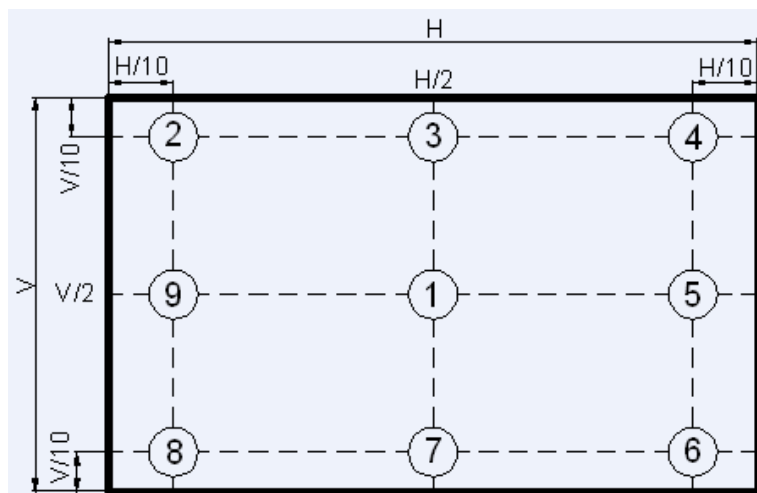



Document Title	M101GWN9 R2 Product Specification			Page No.	11/23
Document No.		Issue date	2014/5/16	Revision	00

### 5.0 Backlight Characteristics (Reference)

**Table 4 LED driver Input and Output Specifications**

ITEM	UNIT	MIN	TYP	MAX	CONDITION	
V <sub>IN_LED</sub>	V	4.5	5	5.5	DUTY=100%	
I <sub>VIN_LED</sub>	mA	-	-	586	V <sub>LED</sub> =4.5V , η=85%	
F <sub>DIM</sub>	Hz	200	-	1K	-	
DUTY	%	5	-	100	-	
EN/PWM	VIH	V	2	-	5	-
	VIL	V	0	-	0.5	-
V <sub>out</sub>	V	11.6	13.2	14	-	
I <sub>OUT</sub>	mA	-	159	-	-	
L <sub>T</sub>	Hours	(30,000)	-	-	LED Life Time	

Note: The LED life time define as the estimated time to 50% degradation of initial luminous.



Document Title	M101GWN9 R2 Product Specification			Page No.	12/23
Document No.		Issue date	2014/5/16	Revision	00

## 6.0 Electrical Characteristics

**Table 5 Connector Name / Designation**

Item	Description
Connector	MSAK24025P40D

**Table 6 Pin Assignment**

Pin #	Signal Name	Description	Remarks
1	BIST	BIST MODE SELECT(High Enable)	FOR INTERNAL TEST
2	VDD	LCD power supply (Typ. +3.3V)	
3	VDD	LCD power supply (Typ. +3.3V)	
4	V_EDID	EDID power supply	
5	NC	No connection	
6	CLK_EDID	EDID CLK signal	
7	Data_EDID	EDID Data signal	
8	LVDS input 0-	LVDS CH0 data signal(-) 、 R0~R5 、 G0	
9	LVDS input 0+	LVDS CH0 data signal(+ ) 、 R0~R5 、 G0	
10	GND	GND	
11	LVDS input 1-	LVDS CH1 data signal(-) 、 G1~G5 、 B0 、 B1	
12	LVDS input 1+	LVDS CH1 data signal(+ ) 、 G1~G5 、 B0 、 B1	
13	GND	GND	
14	LVDS input 2-	LVDS CH2 data signal(-) 、 B2~B5 、 DE	
15	LVDS input 2+	LVDS CH0 data signal(+ ) 、 B2~B5 、 DE	
16	GND	GND	
17	LVDS CLK -	LVDS CLK data signal(-)	
18	LVDS CLK +	LVDS CLK data signal(+)	
19	GND	GND	
20	LVDS input 3-	LVDS CH3 data signal(-) 、 R6~R7 、 G6~G7 、 B6~B7	
21	LVDS input 3+	LVDS CH3 data signal(-) 、 R6~R7 、 G6~G7 、 B6~B7	
22	GND	GND	
23	NC	No connection	
24	NC	No connection	



昆山龙腾光电有限公司  
InfoVision Optoelectronics ( Kunshan ) Co.,LTD.

Document Title	M101GWN9 R2 Product Specification			Page No.	13/23
Document No.		Issue date	2014/5/16	Revision	00

25	GND	GND	
26	NC	No connection	
27	NC	No connection	
28	GND	GND	
29	NC	No connection	
30	NC	No connection	
31	GND	GND	
32	GND	GND	
33	GND	GND	
34	NC	No connection	
35	PWM	LED dimming signal	
36	LED_EN	LED Enable signal	
37	NC	No connection	
38	VLED	LED power supply (Typ. 5V)	
39	VLED	LED power supply (Typ. 5V)	
40	VLED	LED power supply (Typ. 5V)	



Document Title	M101GWN9 R2 Product Specification			Page No.	14/23
Document No.		Issue date	2014/5/16	Revision	00

**Table 7 Electrical Characteristics**

ITEM	SYMBOL	MIN.	TYP.	MAX.	UNIT	CONDITIONS
System Power Supply						
Input Power Supply Voltage	$V_{IN}$	3.0	3.3	3.6	V	
Input Power Supply Current	$I_{VIN}$	-	-	217	mA	Black pattern , 60Hz
Input Inrush Current	$I_{RUSH}$	-	-	1.5	A	0.5ms rise time (10%~90%)
Input Power Voltage Ripple	$V_{RPL}$	-	-	200	mV	Vp-p
LED Power Supply						
Input Power Supply Voltage	$V_{LED-IN}$	4.5	5	5.5	V	
Input Power Supply Current	$I_{IN}$	-	-	586	mA	$V_{LED}=4.5V, \eta=85\%$
EN/PWM	VH	2.0	-	5.0	V	
	VL	0	-	0.5	V	
LVDS Signals						
Differential Input High Threshold	$V_{th}$	-	-	+100	mV	$V_{cm}=+1.2V$
Differential Input Low Threshold	$V_{tl}$	-100	-	-	mV	$V_{cm}=+1.2V$
Magnitude Differential Input Voltage	$ V_{id} $	200	-	600	mV	
Common Mode Voltage	$V_{cm}$	1.0	1.2	1.4	V	$V_{th} - V_{tl} = 200mV$
Common Mode Voltage Offset	$\Delta V_{cm}$	-50	-	+50	mV	$V_{th} - V_{tl} = 200mV$
EDID Power Supply						
Input Power Supply Voltage	$V_{EDID}$	3.0		3.6	V	

- Note: A. Input signals shall be low or Hi-Z state when VIN is off.
- B. All electrical characteristics for LVDS signal are defined and shall be measured at the interface connector of LCD.
- C. White Pattern at 3.3V driving voltage.

Document Title	M101GWN9 R2 Product Specification			Page No.	15/23
Document No.		Issue date	2014/5/16	Revision	00

## 7.0 Interface Timings

### 7.1 Timing Characteristics

**Table 8 Interface Timings**

Synchronization Method : DE only

Parameter	Symbol	Unit	Min.	Typ.	Max.
LVDS Clock Frequency <single>	$f_{dck}$	MHz	45	51.2	65
H Total Time	$T_{hp}$	clocks	1,324	1,344	1,364
H Active Time	HA	clocks	1,024	1,024	1,024
H Blanking Time	$T_{HBLANK}$	clocks	300	320	340
V Total Time	$T_{vp}$	lines	615	635	645
V Active Time	VA	lines	600	600	600
V Blanking Time	$T_{VBLANK}$	lines	15	35	45
V Frequency	$f_v$	Hz	55	60	65

**Figure 7 DE-only timing mode**

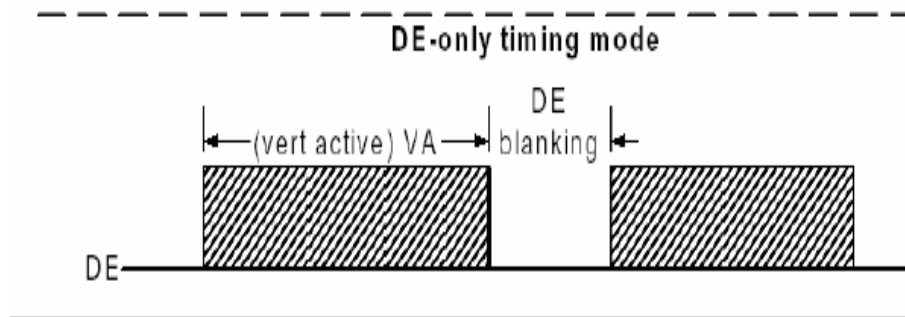

### 7.2 Timing Diagram of Interface Signal

**Figure 8 LVDS Data Mapping**

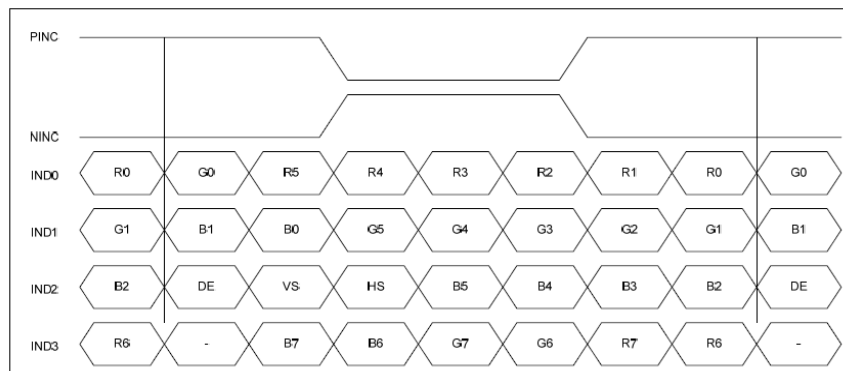

Document Title	M101GWN9 R2 Product Specification			Page No.	16/23
Document No.		Issue date	2014/5/16	Revision	00

### 8.0 Power Consumption

Input power specifications are as follows.

**Table 9 Power Consumption**

Item	Symbol	Min.	Typ.	Max.	Units	Note
Input Power Supply Voltage	$V_{IN}$	3.0	3.3	3.6	V	
Input Power Supply Current	$I_{VIN}$	-	-	217	mA	Black pattern , 60Hz
Input Inrush Current	$I_{RUSH}$	-	-	1.5	A	0.5ms rise time (10%~90%)
Input Power Voltage Ripple	$V_{RPL}$	-	-	200	mV	Vp-p

### 9.0 Power ON/OFF Sequence

**Figure 9 Power Sequence**

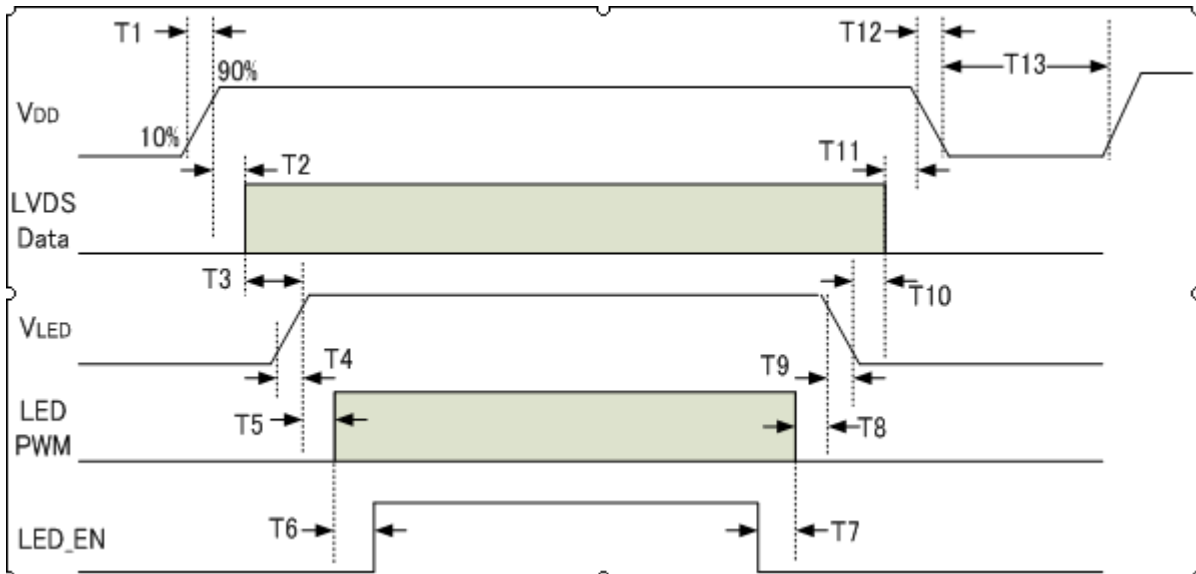





Document Title	M101GWN9 R2 Product Specification			Page No.	17/23
Document No.		Issue date	2014/5/16	Revision	00

**Table 10 Power Sequencing Requirements**

Parameter	Symbol	Unit	min	Typ.	max
VDD rising Time	T1	ms	0.5	--	10
VDD Good to Signal Valid	T2	ms	30	--	90
Signal Valid to Backlight on	T3	ms	200	--	--
Backlight Power on time	T4	ms	0.5	--	--
Backlight VDD Good to System PWM on	T5	ms	10	--	--
System PWM on to Backlight Enable on	T6	ms	10	--	--
Backlight Enable off to System PWM off	T7	ms	0	--	--
System PWM off to B/L Power Disable	T8	ms	10	--	--
Backlight Power off time	T9	ms	1	10	30
Backlight off to signal Disable	T10	ms	200	--	--
Signal Disable to Power Down	T11	ms	0	--	50
VDD Falling Time	T12	ms	1	10	30
Power Off	T13	ms	500	--	--



Document Title	M101GWN9 R2 Product Specification			Page No.	18/23
Document No.		Issue date	2014/5/16	Revision	00

## 10.0 Reliability Test Criteria

Table 11 Reliability Test Criteria

Items	Required Condition	Note
High Temperature Operating Test	70°C, 300hrs	
Low Temperature Operating Test	-20°C, 300hrs	
High Temperature Storage Test	80°C, 300hrs	
Low Temperature Storage Test	-30°C, 300hrs	
High Temperature/High Humidity Operation Test	50°C, 85%, 300hrs	
Thermal Shock Test	-20°C~60°C, 1h/each cycle,100cycles	
Shock Test (Non-Operating)	50G,20ms,Half Sine Wave, (±X, ±Y,±Z)	
Vibration Test (Non-Operating)	1.5G ,10~200 Hz, x、 y、 z each axis/30min	
ESD test	Contact Discharge: ±8KV,150pF(330Ω) ; Air Discharge: ±15KV,150pF(330Ω)	1

Note1: ESD class C: Performance could be recovered by reset if temporary failure happened.



Document Title	M101GWN9 R2 Product Specification	Page No.	19/23
Document No.		Issue date	2014/5/16
		Revision	00

### 11.0 Mechanical Characteristics

Figure 10 Reference Outline Drawing (Front Side)

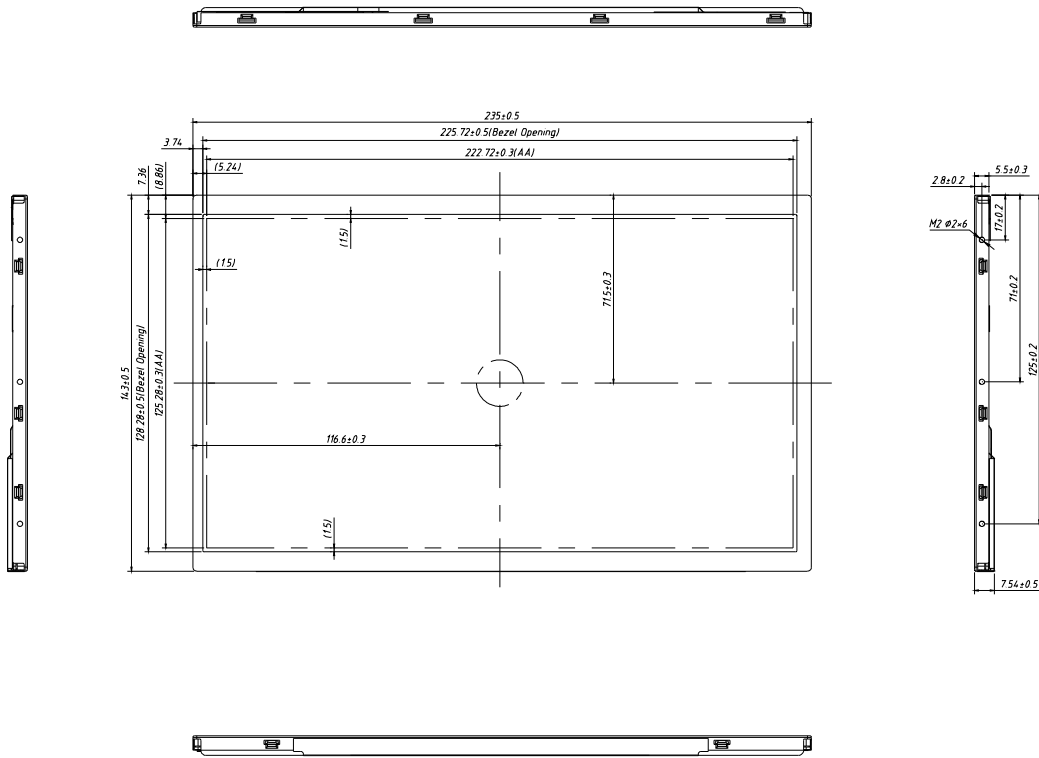
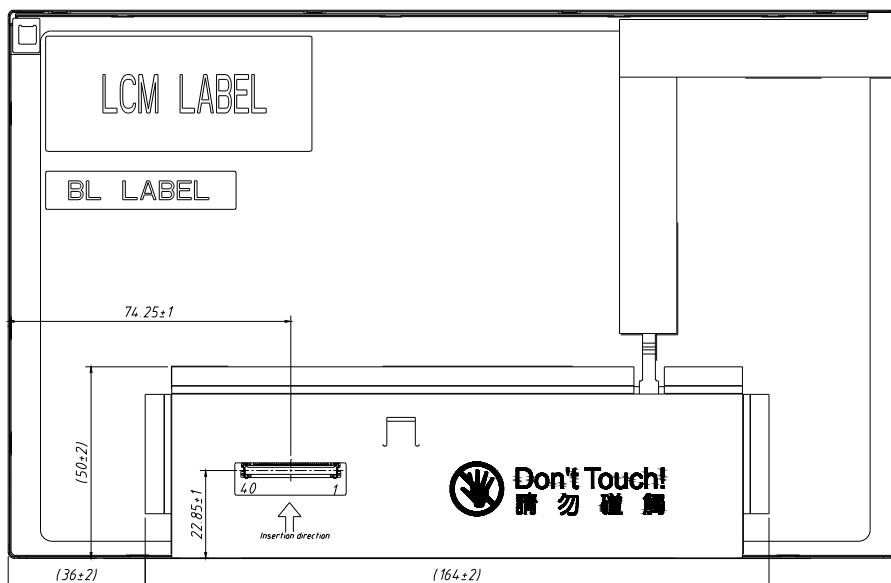

Figure 11 Reference Outline Drawing (Back Side)





Document Title	M101GWN9 R2 Product Specification			Page No.	20/23
Document No.		Issue date	2014/5/16	Revision	00

## 12.0 Package Specification

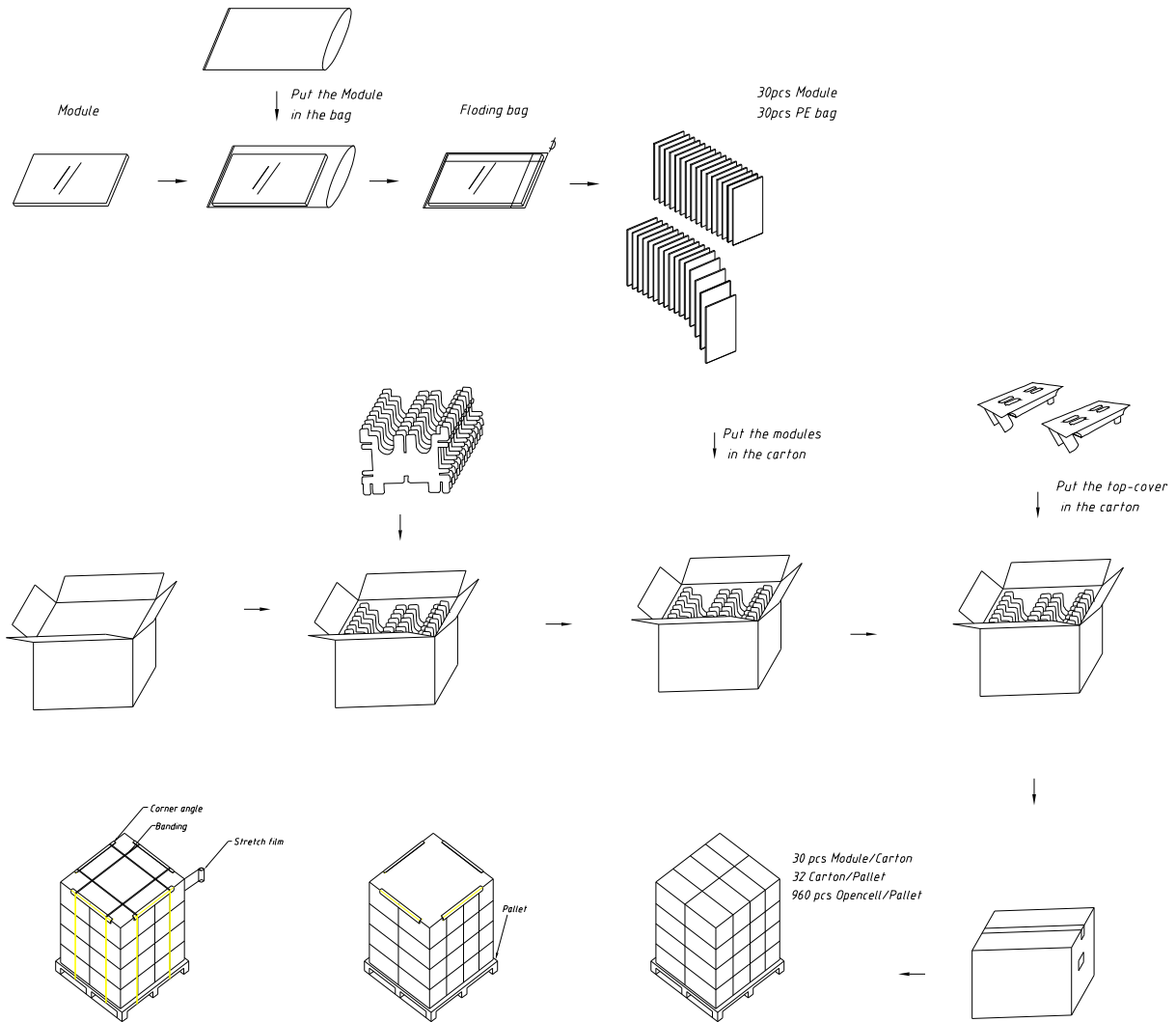



Document Title	M101GWN9 R2 Product Specification			Page No.	21/23
Document No.		Issue date	2014/5/16	Revision	00

### 13.0 Lot Mark

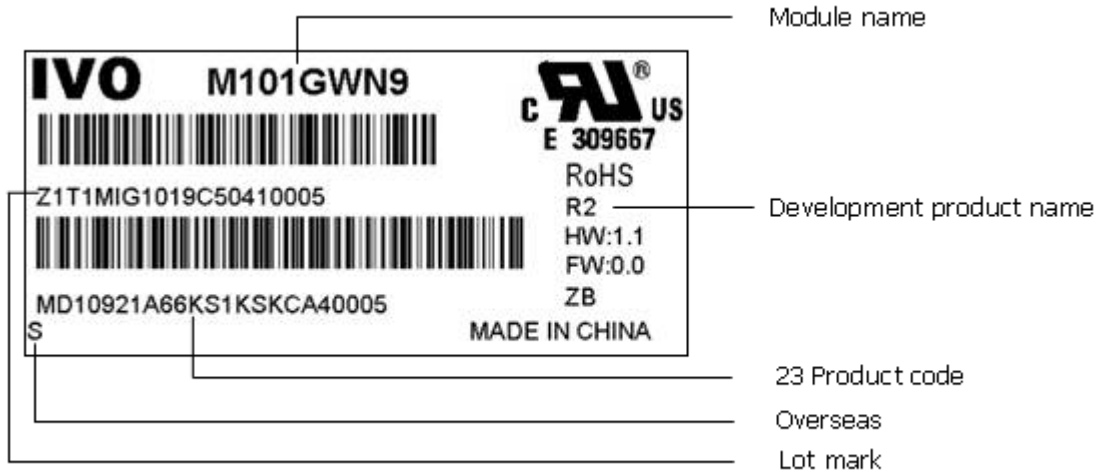

Note: This picture is only a sample.

#### 13.1 Lot Mark

1	2	3	4	5	6	7	8	9	10	11	12	13	14	15	16	17	18	19	20
---	---	---	---	---	---	---	---	---	----	----	----	----	----	----	----	----	----	----	----

Code1,2,4,5,6,7,8,9,10,11,16: IVO internal flow control code.

Code3: Production location.

Code12: Production year.

Code13: Production month.

Code14, 15: Production date.

Code17, 18, 19, 20: Serial number.

Note (1) Production Year

Year	2006	2007	2008	2009	2010	2011	2012	2013	2014	2015
Mark	6	7	8	9	A	B	C	D	E	F

Note (2) Production Month

Month	Jan.	Feb.	Mar.	Apr.	May.	Jun.	Jul.	Aug.	Sep.	Oct	Nov.	Dec.
Mark	1	2	3	4	5	6	7	8	9	A	B	C

#### 13.2 23 Product Barcode

1	2	3	4	5	6	7	8	9	10	11	12	13	14	15	16	17	18	19	20	21	22	23
---	---	---	---	---	---	---	---	---	----	----	----	----	----	----	----	----	----	----	----	----	----	----

Code1, 2: Manufacture District.

Code3, 4, 5, 6, 7: IVO internal module name.

Code8, 9, 10, 13, 16: IVO internal flow control code.

Code11, 12: Cell location Suzhou defined as "SZ".

Code14, 15: Module line Kunshan defined as "KS".

Code17, 18, 19: Year, Month, Day Refer to Note (1) and Note (2) of Lot Mark.

Code20~23: Serial Number.



Document Title	M101GWN9 R2 Product Specification			Page No.	22/23
Document No.		Issue date	2014/5/16	Revision	00

## 14.0 General Precaution

### 14.1 Use Restriction

In case of using the device for life supporting systems, aircraft navigation control systems, military systems and any other application where performance failure could be life-threatening or otherwise catastrophic, take into consideration that appropriate measures such as fail-safe functions and redundant system design should be taken.

### 14.2 Handling Precaution

- (1) Do not disassemble or modify the module. It may damage sensitive parts inside LCD module, and may cause scratches or dust on the display. IVO does not warrant the module, if customers disassemble or modify the module.
- (2) If LCD panel is broken and liquid crystal spills out, do not ingest or inhale liquid Crystal, and do not contact liquid crystal with skin. If liquid crystal contacts mouth or eyes, rinse out with water immediately. If liquid crystal contacts skin or cloths, wash it off immediately with alcohol and Rinse thoroughly with water.
- (3) Disconnect power supply before handling LCD module
- (4) Refrain from strong mechanical shock and /or any force to the module.
- (5) Do not exceed the absolute maximum rating values, such as the supply voltage variation, input voltage variation, variation in parts' parameters, environmental temperature; etc otherwise LCD module may be damaged. It's recommended employing protection circuit for power supply.
- (6) Do not touch, push or rub the polarizer with anything harder than HB pencil lead. Use fingerstalls of soft gloves in order to keep clean display quality, when Persons handle the LCD module for incoming inspection or assembly.
- (7) When the surface is dusty, please wipe gently with absorbent cotton or other soft Material. When cleaning the adhesives, please use absorbent cotton wetted with a little Petroleum benzene or other adequate solvent.
- (8) Wipe off saliva or water drops as soon as possible. If saliva or water drops Contact with polarizer for a long time, they may causes deformation or color Fading.
- (9) Protection film must remove very slowly from the surface of LCD module to Prevent from electrostatic occurrence.
- (10) Because LCD module uses CMOS-IC on circuit board and TFT-LCD panel, it is Very weak to electrostatic discharge, Please be careful with electrostatic Discharge .Persons who handle the module should be grounded through adequate methods.

### 14.3 Storage Precaution

- (1) Please do not leave LCD module in the environment of high humidity and high temperature for a long time.
- (2) The module shall not be exposed under strong light such as direct sunlight. Otherwise, Display characteristics may be changed.
- (3) The module should be stored in a dark place. It is prohibited to apply sunlight or fluorescent light in storage.

### 14.4 Operation Precaution

- (1) Do not connect or disconnect the module in the "Power On" condition.
- (2) Power supply should always be turned on/off by 9.0 "Power on/off sequence"
- (3) Module has high frequency circuits. Sufficient suppression to the electromagnetic interference should be done by system manufacturers. Grounding and shielding



Document Title	M101GWN9 R2 Product Specification			Page No.	23/23
Document No.		Issue date	2014/5/16	Revision	00

methods may be important to minimize the interference.

- (4) After installation of the TFT Module into an enclosure, do not twist nor bend the TFT Module even momentary. At designing the enclosure, it should be taken into consideration that no bending/twisting forces are applied to the TFT Module from outside. Otherwise the TFT Module may be damaged.

#### 14.5 Others

- (1) Ultra-violet ray filter is necessary for outdoor operation.
- (2) Avoid condensation of water which may result in improper operation or disconnection of electrode.
- (3) If the module keeps displaying the same pattern for a long period of time, the image may be "sticked" to the screen.
- (4) This module has its circuitry PCB's on the rear side and should be handled carefully in order not to be stressed.

#### 14.6 Disposal

When disposing LCD module, obey the local environmental regulations.